



Product Selection Guide

Volume 11

Table of Contents

Atmel Microcontroller Portfolio.....	4
AVR 8-bit Microcontroller Offering.....	6
Atmel SMART 32-bit ARM Microcontroller Offering.....	10
Atmel Tools and Software.....	14
Capacitive Touch Interface Devices.....	16
Atmel Automotive Solutions.....	17
Atmel Wireless Platform.....	18
Atmel Smart Metering.....	24
Atmel Security Solutions.....	25
Atmel Memory Solutions.....	26



Inspiring Smart and Secure Connected Designs

Atmel at the Heart of the Connected World

Many electronics industry analysts predict The Internet of Things (IoT) will experience phenomenal growth in the next few years, with connected devices numbering in the tens of billions. Since its inception 30 years ago, Atmel® has provided innovations in the essential building blocks of IoT designs—from embedded processing and connectivity to sensors, security, and software. Atmel ties it all together with a rich ecosystem of design tools, including the free Atmel Studio IDE, making it simple to leverage these industry-leading technologies.

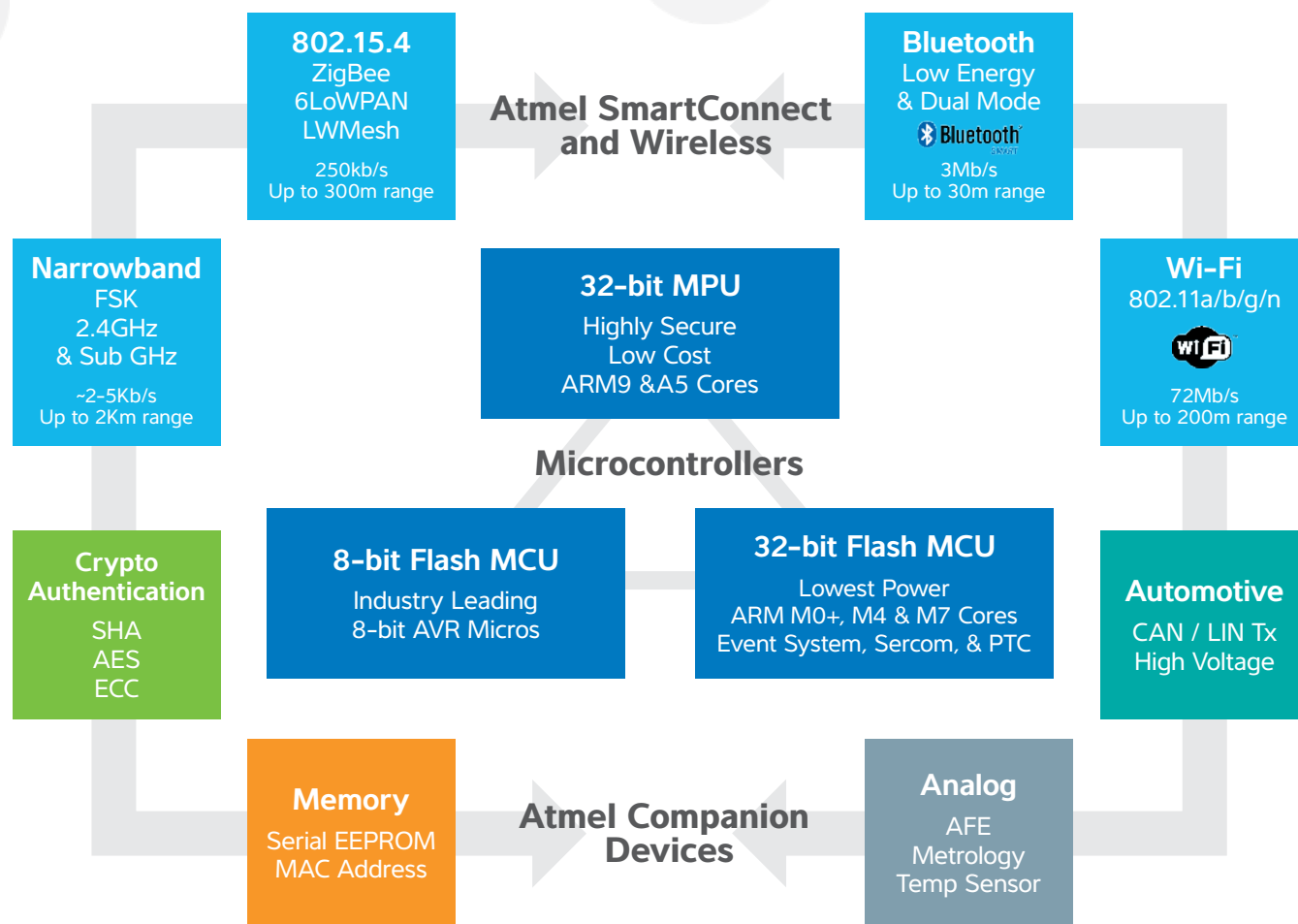

Atmel Microcontroller Portfolio

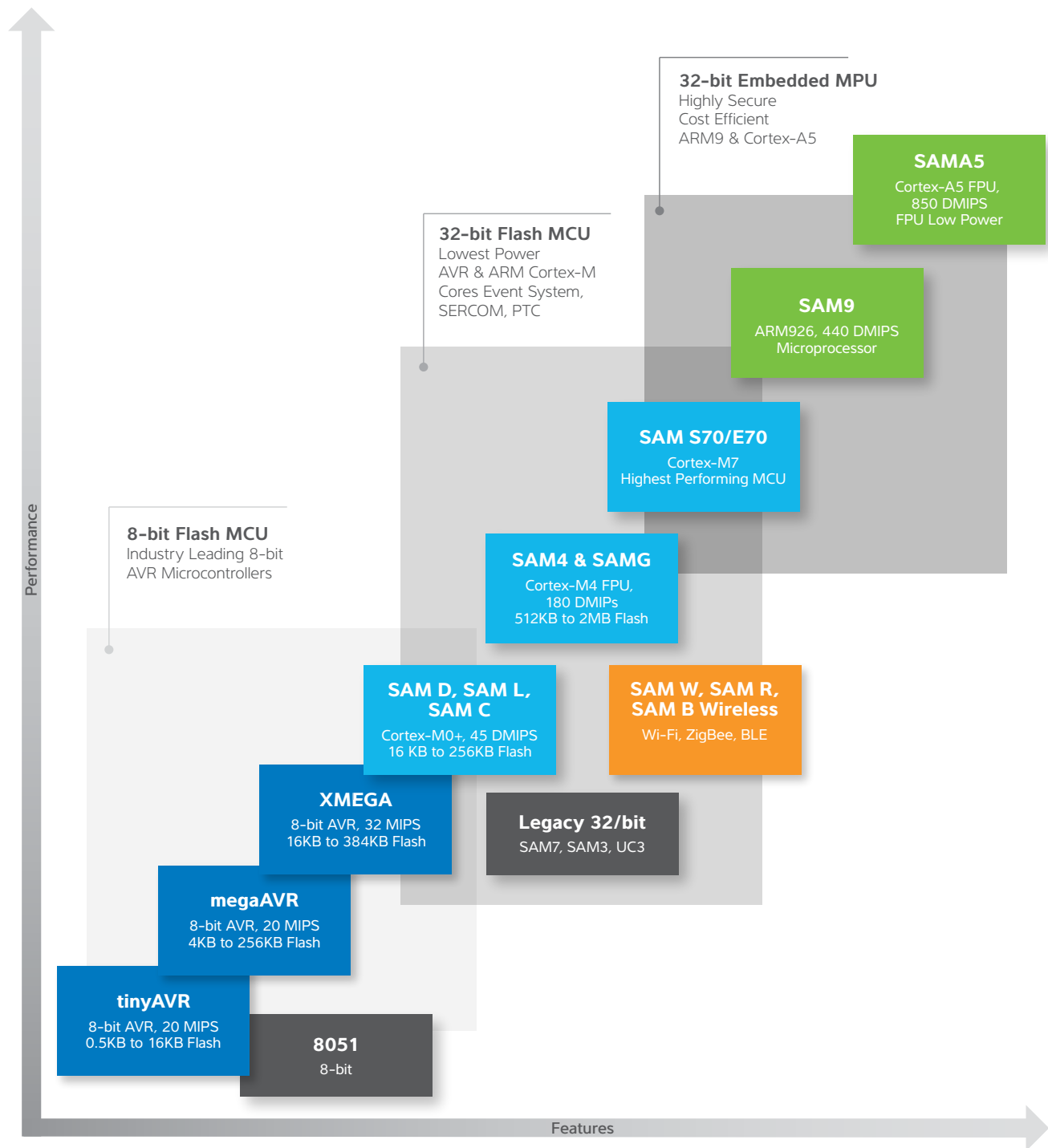

AVR and ARM Cortex-M0+ Families

The world's widest and most successful 8-bit and 32-bit line card

		Automotive	IoT & Sensor Hub	Lighting	Industrial & Appliance	Consumer	Low Power	
AVR	High Performance in a Small Package: tinyAVR	✓		✓	✓	✓	✓	#1 Open Source MCU
	World's Most Popular 8-bit MCU: megaAVR	✓		✓	✓	✓	✓	
	Highest Performance 8-bit: AVR XMEGA				✓	✓	✓	
	32-bit AVR: UC3	✓	✓			✓	✓	
Cortex-M0+	General Purpose: SAM D	✓	✓	✓	✓	✓		Best Cap Touch
	Industry's Lowest Power Cortex-M: SAM L		✓			✓	✓	Industry's Lowest Power
	5V for Industrial & Appliance: SAM C	✓			✓			Best Automotive Touch
	Connected Smart Lighting: SAM R		✓	✓				Industry Only MCU Solution

High Performance ARM Cortex Families

High performance, low power, small footprint MPU and MCU

		IoT & Sensor Hub	Point of Sales	Automotive	Industrial & Appliance	Low Power	Metering	
Cortex-M4	General Purpose SAM4S				✓			Up to 2MB Flash
	Ultra Low Power SAM4L	✓				✓	✓	
	Wearable and Sensor Hub SAM G	✓			✓	✓		Complete Metering Solutions
	Metering SAM4C						✓	
	Ethernet Connectivity SAM4E				✓			
Cortex-M7	Highest Performance MCU SAM S7/E7	✓			✓	✓		Highest Performance Cortex-M
	Automotive M7 with E-AVB SAM V7			✓				
MPU	General Purpose SAM9		✓		✓			Low Power & Small Packages
	Lowest Power MPU SAMA5	✓	✓		✓	✓		

AVR® 8-bit Microcontroller Offering



World's Most Efficient 8-bit CPU

- Single cycle instructions
- 32 working registers
- Designed for high-level languages



Improves efficiency
Reduces code size by 30–60%



Lowest Power Consumption

- picoPower™ technology



Increase battery life
Reduced power supply requirements



Ease of Use

- Atmel development tools
- AVR® Freaks
- Arduino and Maker movement



Faster product development



Scalable Product Family

- ~2000 products available
- Memory, pin and feature options



Reuse of SW and HW

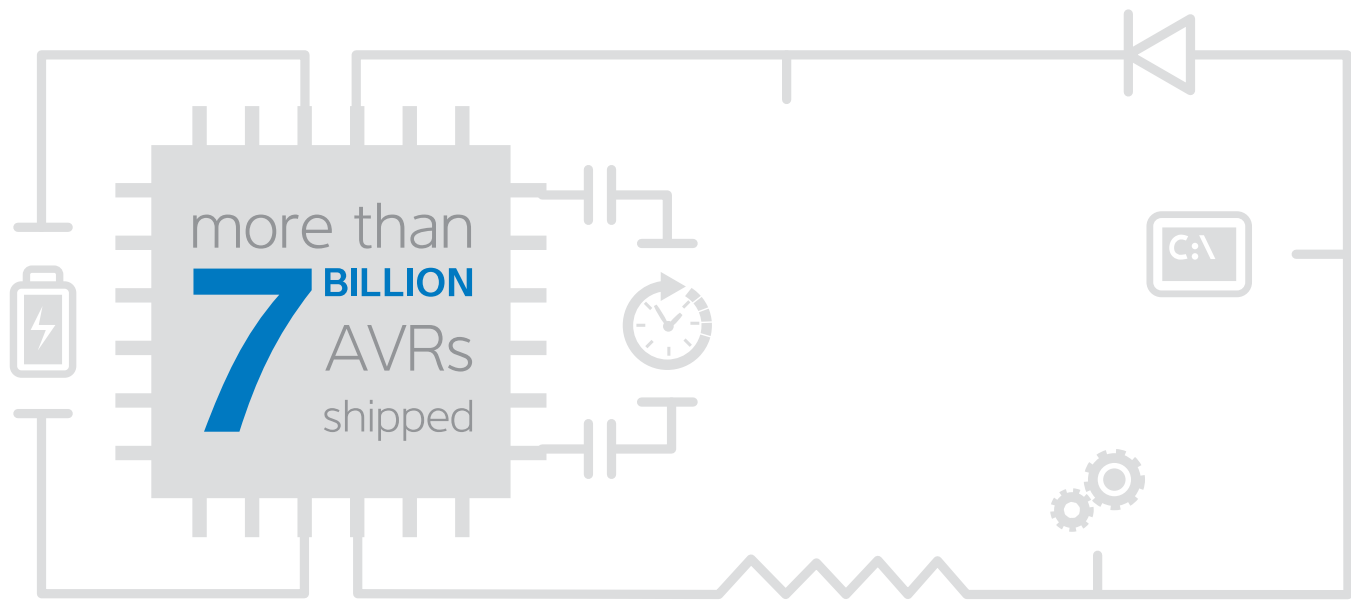

AVR 8-bit Product Families

tinyAVR—Small and Powerful

Part Number	Pins	Flash (KB)	SRAM (B)	EEPROM (B)	I/O	ADC	Packages	Comments
TINY 4	4/6	0.5	32	N/A	4		SOT23-6, UDFN-8	Low Cost
TINY 5	4/6	0.5	32	N/A	4	4 x 8bit	SOT23-6, UDFN-8	Low Cost with ADC
TINY 9	4/6	1	32	N/A	4		SOT23-6, UDFN-8	Low Cost
TINY 10	4/6	1	32	N/A	4	4 x 8bit	SOT23-6, UDFN-8	Low Cost with ADC
TINY 13A	8/10/12	1	64	64	6	4 x 10bit	PDIP-8, SOIC-8, QFN-10, QFN-20	Picopower
TINY 20	14/15/20	2	128	N/A	10/12	8 x 10bit	SOIC-14, TSSOP-14, WCCSP-12, UFBGA-15, VQFN-20	Qtouch
TINY 24A	14/15/20	2	128	128	12	12 x 10bit	SOIC-14, PDIP-14, UFBGA-15, QFN-20, MLF-20, VQFN-20	Diff ADC Gain Stage
TINY 25	8/20	2	128	128	6	4 x 10bit	PDIP-8, SOIC-8, QFN-20, QFN-20	High Speed Diff ADC Gain Stage
TINY 40	20	4	256	N/A	18	8 x 10bit	SOIC-14, TSOP-20, VQFN-20	QTouch
TINY 44A	14	4	256	256	12	8 x 10bit	SOIC-14, PDIP-14, UFBGA-15, QFN-20, MLF-20, VQFN-20	Qtouch Diff ADC Gain Stage
TINY 45	8/20	4	256	256	6	4 x 10bit	PDIP-8, SOIC-8, TSOP-8, QFN-20	High Speed Diff ADC Gain Stage
TINY 48	28/32	8	256	64	24/28	10bit	PDIP-28, QFN-28, QFP-32, QFN-32	Qtouch
TINY 84A	14	8	512	512	12	8 x 10bit	SOIC-14, PDIP-14, UFBGA-15, QFN-20, MLF-20, VQFN-20	Qtouch Diff ADC Gain Stage
TINY 85	8/20	8	512	512	6	4 x 10bit	PDIP-8, SOIC-8, QFN-20	High Speed Diff ADC Gain Stage
TINY 88	28/32	8	512	64	24/28	10 bit	PDIP-28, QFN-28, QFP-32, QFN-32	Qtouch
TINY 102	8	1	32	N/A	6	5 x 10bit	UDFN-8, SOIC-8	USART/SPI
TINY 104	14	1	32	N/A	12	8 x 10bit	SOIC-14	USART/SPI
TINY 261A	20/32	2	128	128	16	11 x 10bit	SOIC-20, PDIP-20, TSOP-20, QFN-32	High Speed PWM Diff ADC Gain Stage
TINY 441	14/20	4	256	128	12	12 x 10bit	SOIC-14, MLF-20, QFN-20	Acc VREF 2% osc Diff ADC Gain Stage
TINY 461A	20/32	4	256	256	16	11 x 10bit	SOIC-20, PDIP-20, TSOP-20, QFN-32	High Speed PWM Diff ADC Gain Stage
TINY 841	14	8	512	256	12	12 x 10bit	SOIC-14, MLF-20, QFN-20	Acc VREF 2% osc Diff ADC Gain Stage
TINY 861A	20/32	8	512	512	16	11 x 10bit	SOIC-20, PDIP-20, TSOP-20, QFN-32	High Speed PWM Diff ADC Gain Stage
TINY 1634	20	16	256	1	18	12 x 10bit	SOIC-20, QFN-20	2 x USART



AVR 8-bit Product Families (Continued)

megaAVR—Robust and Flexible

Part Number	Pins	Flash (KB)	SRAM (KB)	EEPROM (KB)	I/O	ADC	Packages	Comments
MEGA16A	40/44	16	1	0.5	32	8 x 10bit	PDIP-40, MLF-44, QFP-44	Low Cost QTouch
MEGA32A	40/44	32	2	1	32	8 x 10bit	PDIP-40, MLF-44, QFP-44	Low Cost QTouch
MEGA48PB	32	4	0.5	0.25	27	8 x 10bit	MLF-32, QFP-32	
MEGA64A	64	64	2	N/A	53	8 x 10bit	MLF-64, QFP-64	
MEGA88PB	32	8	1	0.5	23	8 x 10bit	MLF-32, QFP-32	
MEGA162	40/44	16	1	0.5	35	N/A	PDIP-40, MLF-44, QFP-44	
MEGA164PA	40/44/49	16	1	0.5	32	8 x 10bit	PDIP-40, MLF-44, QFP-44	
MEGA168PB	32	16	1	0.5	27	8 x 10bit	MLF-32, QFP-32	
MEGA169PA	64	16	1	0.5	54	8 x 10bit	MLF-64, QFP-64, QFN-64	
MEGA324PB	44	32	2	1	39	8 x 10bit	MLF-44, QFP-44	
MEGA328PB	32	32	2	1	27	8 x 10bit	MLF-32, QFP-32	
MEGA329PA	64	32	2	1	54	8 x 10bit	MLF-64, QFP-64	
MEGA 640	100	64	8	4	86	16 x 10bit	BGA-100, QFP-100	
MEGA 644PA	40/44	64	4	2	32	8 x 10bit	PDIP-40, MLF-44, QFP-44	
MEGA 649P	64	64	4	2	54	8 x 10bit	MLF-64, QFP-64	
MEGA 1280	100	128	8	4	86	16 x 10bit	BGA-100, QFP-100	
MEGA 1281	64	128	8	4	54	16 x 10bit	MLF-64, QFP-64	
MEGA 1284	40/44	128	16	4	32	8 x 10bit	PDIP-40, MLF-44, QFP-44	
MEGA 2560	100	256	8	4	86	16 x 10bit	BGA-100, QFP-100	
MEGA 2561	64	256	8	4	54	8 x 10bit	MLF-64, QFP-64	
MEGA3290P	100	32	2	1	69	8 x 10bit	QFP-100	LCD PicoPower
MEGA6490P	100	64	4	2	69	8 x 10bit	QFP-100	LCD PicoPower
MEGA 8515	40/44	8	0.5	0.5	35	N/A	PDIP-40, MLF-44, QFP-44	External SRAM
MEGA 8535	40/44	8	0.5	0.5	32	8 x 10bit	PDIP-40, MLF-44, QFP-44	

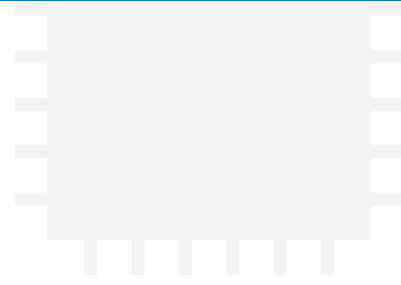

XMEGA—More Performance

Part Number	Pins	Flash (KB)	SRAM (KB)	EEPROM (KB)	I/O	ADC	Packages	Comments
A1U	100	64/128	4/8	2	78	2 - 16 x 12bit 2msps	TQFP-100, BGA-100 VFPGA-100	Event System USB2.0
A3U	64	64/128 192/256	4/8/16	2/4	50	2 - 16 x 12bit 2msps	TQFP-64, QFN-64	Event System USB2.0 Qtouch
A4U	44	16/32 64/128	2/4/8	1/2	34	12 x 12bit 2msps	QFP-44, QFN-44 VFPGA-49	Event System USB2.0 Qtouch
B1	100	64/128	4/8	2	53	2 - 8 x 12bit	TQFP-100, VFPGA-100	PicoPower 4x40 Segment LCD USB 2.0
B3	64	64/128	4/8	2	36	1 - 8 x 12bit	TQFP-64, QFN-64 DRQFN-64	PicoPower 4x25 Segment LCD USB 2.0
C3	64	32/64 128/192 256/384	2/4/8/16	4/8/16	50	1 - 16 x 12bit	TQFP-64, VQFN-64	PicoPower Event System Full Speed USB
C4	44	16/32	2/4	1	34	1 - 16 x 12bit	TQFP-44, QFN-44 VFPGA-49	PicoPower Event System Full Speed USB
D3	64	32/64 128/192 256/384	4/8 16/32	1/2/4	50	1 - 16 x 12bit	TQFP-64, QFN-64	PicoPower Event System QTouch
D4	44	16/32 64/128	1/2/4/8	1/2/4	34	1 - 12 x 12bit	TQFP-44, VFPGA-49	PicoPower Event System Qtouch
E5	32	8/16/32	1/2/4	0.5/1	26	1 - 16 x 12bit	QFP-44, QFN-44 UQFN-44	PicoPower Event System Custom Config Logic

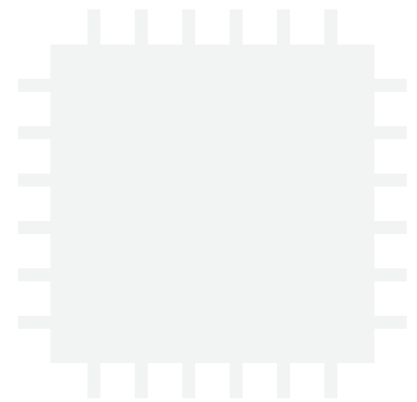
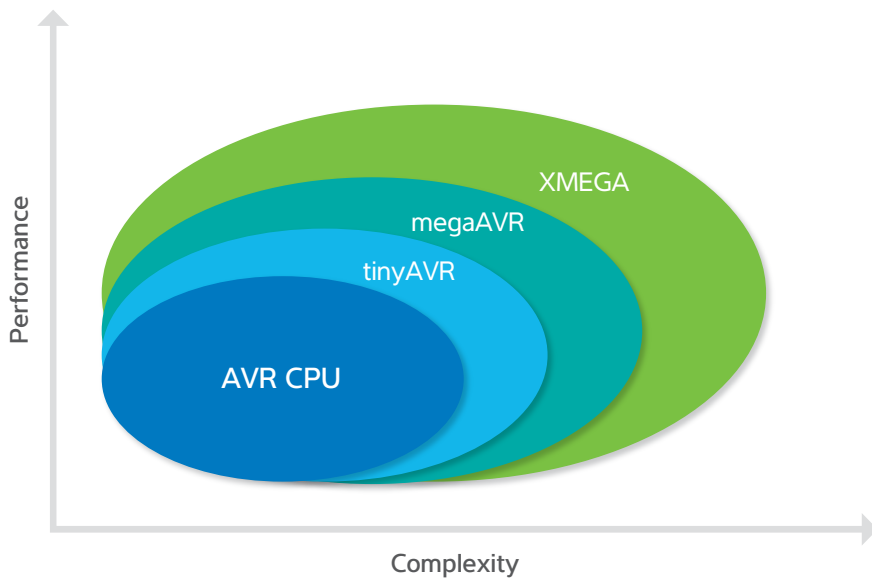



Atmel | SMART 32-bit ARM Microcontroller Offering

Broad ARM Cortex M0+ Offerings

SAM D, SAM L and SAM C Series

SAM D Family Features	SAM D10	SAM D11	SAM D20	SAM D21	SAM L21/22	SAM C20/21
Cortex M0+	8-16KB Flash		16-256KB Flash	32-256KB Flash		
Event System	14, 20 and 24 pins		32, 48 and 64 pins			
SERCOM	14, 20 and 24 pins		32, 48 and 64 pins			
PTC	6-ch DMA			12-ch DMA	16-ch DMA	12-ch DMA
10-bit 350 ksps DAC	6-ch DMA			12-ch DMA	16-ch DMA	12-ch DMA
2xAnalog Comparator	1x T/C for Control			3x T/C for Control		
32-bit RTC with Calendar	1x T/C for Control			3x T/C for Control		
Serial Wire Debug	12-bit 350Ksps ADC				12-bit, 20ch, 1Msps ADC*	
BOR and POR		FS USB Device		FS USB H&D		
Internal RCs		FS USB Device		FS USB H&D		
Watchdog				I ² S	SLCD*	HW Div
High GPIO Count						5V Operation
Comments					• SAML22 has integrated SLCD	• SAMC21 has 16 bit Sigma Delta • SAMC20 has 12 channel 1MSPS ADC

Series Descriptions

- SAM D09 – The smallest member of the SAM D family in terms of memory, pin count, and features. Compatible with the SAM D10, SAM D11, SAMD20, and SAM D21.
- SAM D10/11 – Feature upgrade from the SAM D09 with additional serial interfaces, timers, Analog Comparator, DAC, and Peripheral Touch Controller.
- SAM D20/21 – Offers a rich set of peripherals, flexibility, and ease-of-use with low power consumption Full Speed USB, DMA, high-end timers/counters
- SAM DA1 – Automotive qualified microcontrollers, embedding Peripheral Touch Controller (PTC) enabling efficient Button/Slider/Wheel and Proximity detection solutions for automotive HMI applications
- SAM L21/22 – Ultra Low Power version featuring 35uA/MHz in active mode, 1Msps ADC and DAC, Custom Configurable Logic, PTC and more
- SAM C20/21 – 5V version for Industrial applications that need to interface with higher powered devices. Features CAN, RS485, 16-bit Sigma Delta ADC and QTouch

Atmel ARM Cortex-M4 Summary

SAM4 & SAM G

SAM 4/G Family Features	SAM4N	SAM4S	SAM4E	SAM4L	SAM G
Cortex M4/M4F	100 MHz	120 MHz	120 MHz	48 MHz	120 MHz
Up to 2MB Dual Bank Flash	512KB-1MB Single Bank	128KB-2MB Single/Dual Bank Cache	512KB-1MB Single Bank Cache	128-512KB Single Bank	256-512KB Single Bank Cache
High I/O Pin	-	-	-	-	-
DMA	48, 64 and 100 pins		100, 144 pins	48, 64 and 100 pins	49 and 64 pins
Communication (USB, CAN, Ethernet)			DMA	DMA	DMA
CMOS Interface		FS USB Device	FS USB Device	FS USB H&D	
Safety and Security		-	2x CAN	-	
I ² S		-	1x Ethernet	-	
		CMOS Interface			
		CRC	CRC	CRC	CRC
		-	AES 256	AES 256	-
		-	-	RNG	-
		I ² S		I ² S	I ² S

Series Descriptions

- SAM4N – Ideal for a wide range of applications in industrial automation, consumer and appliance, and energy metering markets. Pin compatible with SAM3S, SAM3N and SAM7S,
- SAM4S – Features a multi-layer bus matrix, multi-channel direct memory access (DMA) and distributed memory to support high data rate communication.
- SAM4E – Offers a rich set of connectivity peripherals including 10/100Mbps Ethernet MAC supporting IEEE1588 and dual CAN as well as single-precision FPU.
- SAM4L – Ideal for power sensitive designs delivering down to 90uA/MHz in active mode as well as sleep mode with full RAM retention of 1.5uA and wake-up time of 1.5us.
- SAM G – Optimized for ultra-low power and high performance. Small form factor bundled with FPU, DMA and good SRAM to flash ratio in a very tiny 3x3mm package



Atmel | SMART ARM Cortex-M7 MCU Family

Perfectly matching the increasing application requirements

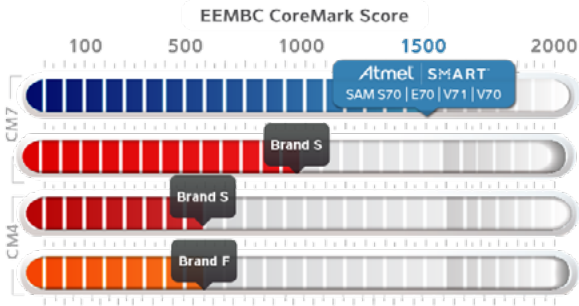

	SAM S70	SAM E70	SAM V70	SAM V71
Frequency	300MHz			
Flash	512KB/1MB/2MB			
SRAM	256KB/384KB/384KB			
Backup SRAM	1KB			
Ext Bus Interface	16-bit (SDRAM, SRAM)			
Ethernet 1588 (MAC)	-	10/100 Mbps	-	10/100 Mbps
CAN-FD	-	2	2	2
Media LB	-		Yes	
Automotive qualified	-		Yes	
Camera interface		1		
QSPI		1		
HSMCI/SDIO/eMMC		1		
USB	1x HS (Host/Device)			
USART or SPI/UART	5/3			
SPI/I ² C/SSC	2/3/1			
12-bit ADC	2x 12-ch 2Mbps			
12-bit DAC	2-ch 2 Mbps			
Timers/PWM	12/8			
Crypto	TRNG, AES256, SHA1/256			
Pin count	64-100-144			
Package	QFP, BGA			

High Performance

- ARM Cortex-M7 – 300MHz, 1500 CoreMark
- 16KB+ 16KB of I&D cache with ECC
- Execution in place from on-chip flash, NVM connected to QSPI and EBI
- Multi-port SRAM minimizing latency
- User configurable SRAM and TCM size

Features

- HS USB host/device with integrated PHY
- Memory integrity check monitor
- CMOS camera interface
- Ethernet and dual CAN on SAM E70
- Sleepwalking on UART and I²C
- Event system

Advanced Analog Front-end (AFE)

- Dual S&H, 12-bit ADC, 16-bit HW averaging
- Differential input, programmable gain
- Automatic gain and offset error correction
- DMA support, HW & SW trigger

Extended Industrial Temperature

- -40 to 105°C

Atmel eMPU Product Portfolio

Offers rich, peripheral set, low power and ease of use

	SAMA5D2	SAMA5D3	SAMA5D4
Max CPU/DDR speed (MHz)	500/166	536/166	600/200
Neon	✓	--	✓
L2 cache (KB)	128	--	128
DDR3 & Quad SPI	✓	--	--
USB HSIC	✓	--	--
EMAC	1x 10/100	1x Gbit 1x 10/100	2x 10/100
CAN	✓	✓	--
LCD Interface	✓	✓	✓
Video	--	--	Yes (720p)
Thrust Zone	✓	--	✓
On-the-fly memory encryption/Tamper detection	✓	--	✓
Temperature range up to 105°	✓	✓	--

SAMA5D2 series:

The Atmel | SMART SAMA5D2 series extends the SAMA5 family by offering great features integrated into lower pin count packages, making it ideal for applications where security, power consumption or space constraints are key considerations.

SAMA5D3 series:

Operating at 850DMIPS at under 150mW, the Atmel | SMART SAMA5D3 MPU is ideal for any high-performance, low-power and cost-sensitive industrial application.

SAMA5D4 series:

The Atmel | SMART SAMA5D4 MPU operates at 945DMIPS, includes a 720p hardware video decoder and high level of security making it ideal for any high-performance, secure and cost-sensitive industrial application requiring video playback. **Updated ASD4 speed from 528Mhz to 600Mhz.**

Atmel Tools and Software

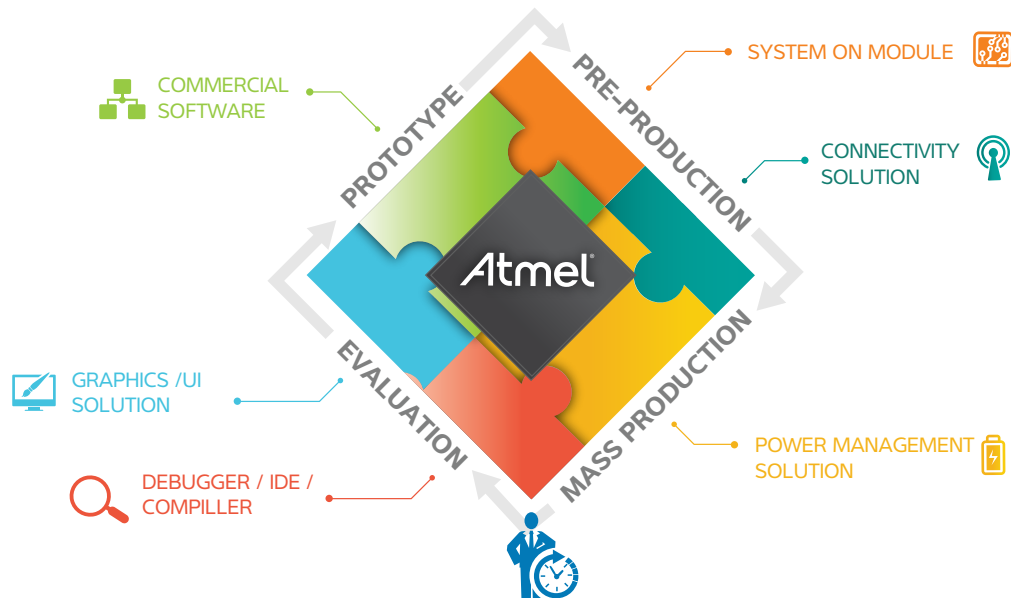

Atmel Studio 7

Available for free at atmel.com

Powerful

- Based on Visual Studio 2015 frontend
- Supports 8/32-bit AVR and ARM development and debugging for Atmel MCU targets
- Supports project migration from earlier Studio versions

Easy to Use

- Extensive embedded software library
- Integrated training modules and examples

Extensible

- Rich 3rd-party ecosystem of plugins
- Configuration tools for Atmel Touch and Wireless technologies
- Supports data and power visualization

700,000+
Studio downloads
since 2012

93%
Users ratings
excellent,
very good, good

Atmel START

Web-based Software Configuration & Deployment Engine

- Automatic software integration engine, lets developers focus on their application instead of integrating off-the-shelf software.
- Intuitive graphical Software configuration
- Deploy software to Atmel board, or users own custom board
- Supports “top down” evaluation of Atmel technology



Atmel Power Debugger

Combined Debugger and Power Measurement Probe

- Simultaneous debugging and power measuring
- Two independent channels for power measurement
- CDC virtual COM port
- DGI for streaming application & power data
- Provides target power, 1.6 – 5.5V, up to 100mA
- Status LEDs for debugging and target supply

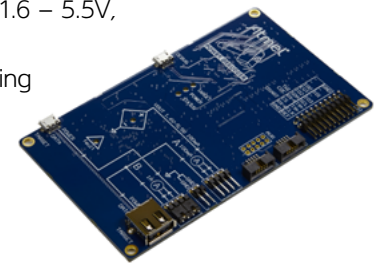

Atmel Data Visualizer

View MCU Data at Runtime

- MCU Data streamed from power debugger to Data Visualizer
- Viewed in configurable UI Objects
- Oscilloscope view, text terminal, buttons, checkboxes, gauges, textbox...
- Can run as Studio 7 plug-in, or stand alone

Power Analysis (Xplained Pro kits w/ XPM and Power Debugger Probe)

- Power and Battery estimation between cursors over duty cycle
- Correlation between current consumption and code location

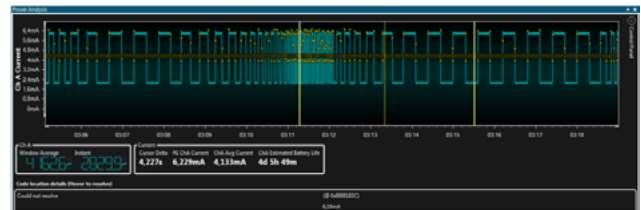
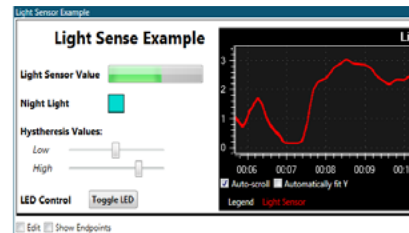

Capacitive Touch Interface Devices

Touching the Connected Car

Opportunities for capacitive touch technologies

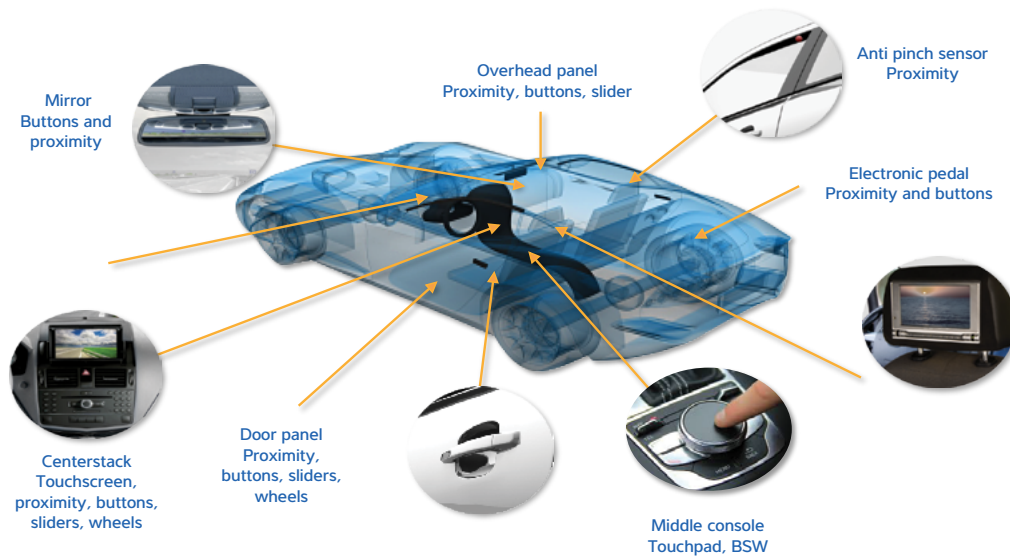

Peripheral Touch Controller — PTC

HW Module for Capacitive Touch Sensing

- Buttons, Sliders, and Wheels
- Mutual- and self-capacitive touch
 - Can run both at the same time
 - Self-(re)calibrating, no tuning needed
 - No external components needed
- Excellent conducted immunity (CI)
 - Built-in hardware filtering
 - Passes 10V CI*
- Low standby power consumption
 - 4µ stand with wake-up touch
- Low CPU utilization
 - Autonomous operation
 - Non blocking interrupt behavior
- High channel count
 - Up to 256 mutual cap channels
 - Up to 32 self cap channels

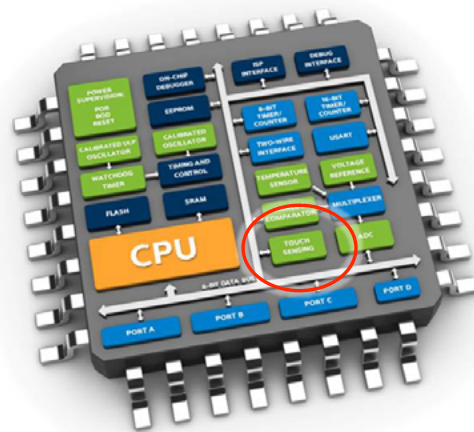

* 100K series resistor might be needed in some designs

Atmel Automotive Solutions

You can rely on Atmel with over 30 years of design experience and expertise in the automotive field. You can also depend on us to support you with extensive demonstration and evaluation kits, reference boards, software, detailed documentation, and our expert staff of application engineers.

Automotive Microcontrollers

Our wide range of cost-effective, top-quality products with fully functional design kits support your designs, whether they are large, complex electronic systems for automotive safety or body control, or smaller, independent applications.

Automotive Serial EEPROMs

We offer a complete line of automotive temperature grade Serial EEPROMs supporting I²C, SPI and Microwire protocols. These products are ideal for high-speed designs in robust and noisy environments.

Automotive Touch

The maXTouch[®] family — known for its superior performance and rich feature set — is now qualified for automotive applications such as automotive touchscreens and touchpads used in center stack displays, navigation systems, radio human-machine interfaces (HMIs) and rear-seat entertainment systems.

Broadcast Radio

Backed by more than 30 years' experience in designing broadcast radio solutions, as well as support for industry standards (ISO9001 and ISO16949), our solutions are ideal for the quality and performance requirements of the car radio market.

CAN/VAN Networking

Controller Area Network (CAN) networking is widely used in electronic architectures for today's modern vehicles. Atmel offers a wide range of solutions for CAN networking, including AVR 8-bit RISC microcontrollers and transceivers ready to go with data-rates up to 5Mbit/s supporting the new CAN Flexible Data-rate standard (CAN FD).



Car Access

Our devices support access applications including remote keyless entry (RKE) and passive entry/go (PEG) systems, so you can deliver the convenience as well as security that drivers expect.

Drivers/High-Temperature ICs

With our devices, you can meet the stringent requirements of "under the hood" systems. We understand that high temperatures, strong mechanical vibration and fluctuating electromagnetic fields require products based on decades of good architecture, meticulous manufacturing and robust testing.

Battery Management

Lithium-Ion (Li-Ion) batteries tend to overheat when overcharged or during deep discharge, so our devices are equipped to provide protection and safety features that are critical in high cell count Li-Ion battery applications.

LIN Networking

Our devices support the low-cost local interconnect networking (LIN) systems that are used throughout automobiles for comfort, powertrain, sensor and actuator applications.

Atmel Wireless SmartConnect IoT Platform

Enabling Connectivity Solutions

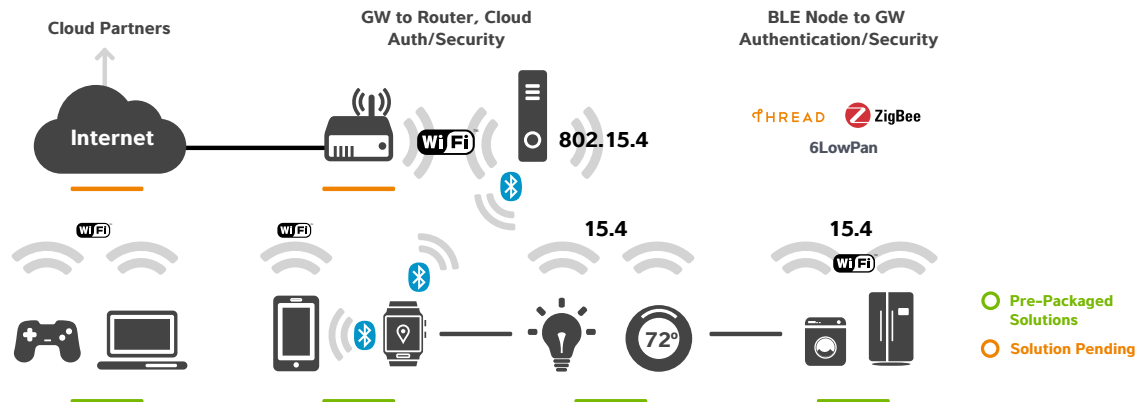

Sub GHz	Wi-Fi 802.11	BT/BLE	ZigBee 802.15.4
<p>ATA 8515 Transceiver w/ AVR MCU</p> <p>ATA 8510 Transceiver MCU + Flash</p> <p>ATA 8215 Receiver w/ AVR MCU</p> <p>ATA 8210 Receiver MCU + Flash</p> <p>ATA 840x Transmitter</p> <p>ATA 874x Transmitter MCU + Flash</p>	<p>SAM W25 802.11bgn Standalone Module</p> <p>WINC 1500 802.11bgn Network Controller Module</p> <p>* WINC3400 802.11bgn/BLE4.0 Combo Network Controller Module</p> <p>WILC 1000 802.11bgn LINK Controller Module</p>	<p>SAMB11 BLE4.1 Standalone Module</p> <p>BTLC 1000 BLE4.1 Link Controller Module</p>	<p>86RF215 Sub-G & 2.4G Dual Band Radio</p> <p>MEGA RFR 2.4G Standalone SiP/Module</p> <p>86RF212B Sub-G ZigBit Module</p> <p>86RF212B Sub-G Radio</p> <p>SAM R21 2.4G Standalone SiP/Module</p> <p>86RF23x 2.4G ZigBit Module</p> <p>86RF23x 2.4G Radio</p>

* Customer Sampling

WILC1000 Network Controllers Series

Ordering Codes	Description
ATWILC1000B-MU-T/Y	Single 802.11 b/g/n chip, 5X5 QFN (Tape & Reel / Tray)
ATWILC1000B-UU-T/Y	Single 802.11 b/g/n chip, 3x3 CSP PKG (Tape & Reel / Tray)
ATWILC1000-MR110PB	Certified WILC1000B Module W/ PCB Antenna
ATWILC1000-MR110UB	Certified WILC1000B Module W/ uFL connector
ATWILC1000-SDPRO	ATWILC1000-SDRO extension board to connect over SD/MMC (SDIO) to peer host

Key Features:

- IEEE 802.11 b/g/n (1x1) for up to 72 Mbps
- Integrated PA and T/R switch
- Superior sensitivity and range via advanced PHY signal processing
- Wi-Fi Direct, station mode and Soft-AP support
- Supports IEEE 802.11 WEP, WPA
- On-chip memory management engine to reduce host load
- SPI, SDIO, UART and I²C as host interfaces
- WSC (wireless simple configuration WPS)

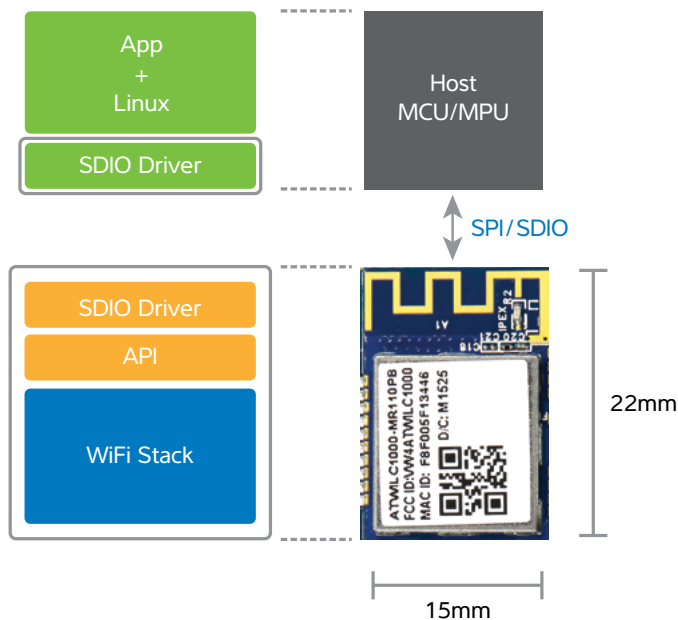

WINC1500 Network Controllers Series

	WINC1500 MR210PB/UB	WINC1510 MR210PB/UB
Wi-Fi SoC	WINC1500B	WINC1510B
External Host Type	MCU	MCU
External Host Interface	UART, SPI	UART, SPI
Single Band 802.11n	✓	✓
WPS,WPA/WPA2 Supplicant	✓	✓
TCP/UDP, DNS, HTTP/ HTTPS, TLS	✓	✓
Stacked Flash	4M	8M
Antenna Design	PCB/uFL	PCB/uFL
OTA Upgrade	✓	✓
Dimensions	22 x15mm	
Pin Out	28x castellation	
Certification	FCC, IC, ETSI	
Availability (MP)	NOW	

Key Features:

- IEEE 802.11 b/g/n (1x1) for up to 72 Mbps
- Integrated PA and T/R switch
- Superior sensitivity and range via advanced PHY signal processing
- Wi-Fi Direct, station mode and Soft-AP support
- Supports IEEE 802.11 WEP, WPA
- On-chip memory management engine to reduce host load
- 4/8 Mbit stacked Flash memory with OTA firmware upgrade
- SPI, UART and I2C as host interfaces
- TCP/IP protocol stack (client/server) sockets applications
- Network protocols (DHCP/DNS), including secure TLS stack
- WSC (wireless simple configuration WPS)

Certified module used as a turn key add-on module adding Wi-Fi connectivity to an existing system.

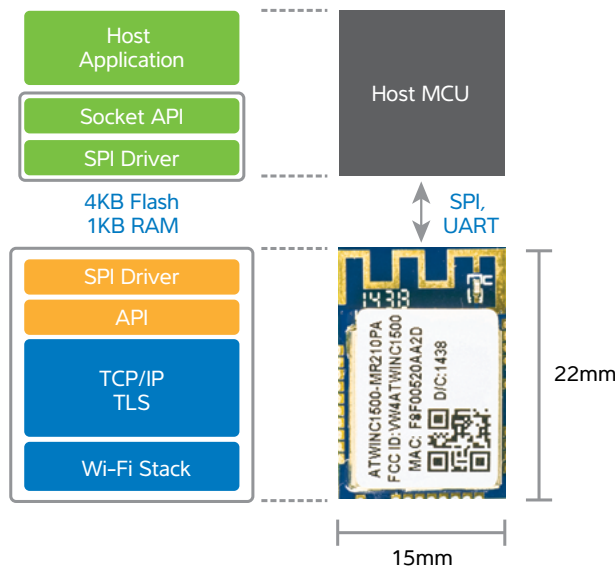

Atmel | SMART SAM W25

Standalone Applications Wi-Fi Module

Key Features:

- IEEE 802.11 b/g/n (1x1) for up to 72 Mbps
- Integrated PA and T/R switch can operate completely host-less in most applications
- Superior sensitivity and range via advanced PHY signal processing
- Wi-Fi Direct, station mode and Soft-AP support
- Supports IEEE 802.11 WEP, WPA
- On-chip memory management engine to reduce host load
- 4 Mbit internal Flash memory with OTA firmware upgrade
- SPI, UART and I²C as host interfaces
- TCP/IP protocol stack (client/server) sockets applications
- Network protocols (DHCP/DNS), including secure TLS stack
- WSC (wireless simple configuration WPS)

	SAMW25H18 -MR210PB	SAMW25H18 -MR510PB
Wi-Fi SoC	WINC1510B	WINC1510B
Embedded Host MCU	SAM D21	SAM D21
Single Band 802.11n	✓	✓
WPS,WPA/WPA2 Supplicant	✓	✓
TCP/UDP, DNS, HTTP/HTTPS, TLS	✓	✓
CryptoAuthentication (ECC508A)	-	✓
Antenna Design	PCB	PCB
OTA Upgrade	✓	✓
Dimensions	34 x15mm	
Pin Out	51 castellations	
Certification	FCC, IC, ETSI, TELEC	
Availability (MP)	NOW	

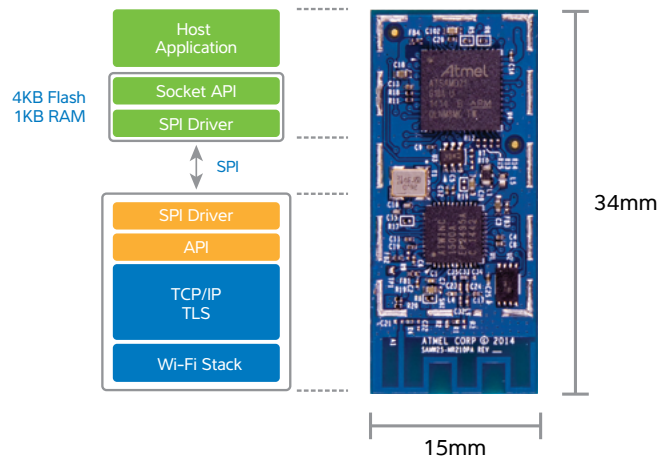



Atmel | SMART SAMR21 ARM Cortex-M0+ with 2.4 GHz 802.15.4 Transceiver

Memories

- 64/128/256/768 (256+512) flash
- 8K/16K/32KB SRAM

Peripherals

- 4-SERCOM interfaces
- I²C, SPI, and USART
- 4x16 bit timers
- 4-Ch 12-bit ADC
- Analog comparator

Sleep Power Consumption

- <150µA/MHz active (CoreMark®)
- <4µA with RTC and Full RAM retention

Key features

- HW AES
- Automatic external FEM control, antenna diversity
- Capacitive touch HW engine (PTC)
- Integrated 32KHz crystal
- Ranging engine

Package Options

- 32pin 5x5mm, 48pin 7x7mm

Link Controller	SAM R21
CPU Core	ARM Cortex-M0+ @ 48MHz
Max PHY Rate	2Mbit
Frequency	2.4GHz
Stacks	Bitcloud, Contiki, OpenWSN Coming:mBED, Thread, iControl
Applications	Lighting, Sensor Networks, Home Automation, ESL
Interfaces	SPI, UART
Tx/Rx Peak	13.8mA/11.8mA @ 3.0V
Tx Pout	+4dBrn
Rx Sensitivity	-99dBrn
Sleep Mode	<4uA (RTC+RAM)
Package	6x6 QFN48 5x5 QFN32
Power Supply	1.8V-3.6V
Temp Range	-40 to +125°C

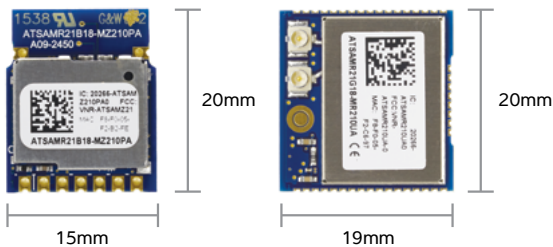

SAM R21 Lighting Module

SAM R21 Module

	SAMR21B18-MZ210PA	SAMR21G18-MR210UA
Target Market	Lighting	General Purpose
Form Factor	15 x 20mm	19 x 20mm
Microcontroller	SAMR21E18	SAMR21G18
RF Output Power	+4dBm	+3.5dBm
Rx Sensitivity	-99dBm	-98dBm
Antenna	PCB trace	2 x UFL
Available I/O	5	17
Encryption		ECC508A
Temperature Range	-40C - +125C	-40C - +85C

Atmel Bluetooth SMART® Solutions

The Lowest Power, Smallest Size Bluetooth® Smart Solution in the Industry.

- Small size enables new ultra small product forms
- Goes the longest without a charge or battery change
- Simplify your design with the Atmel® Studio and Xplained PRO ecosystem
- Easily combine Atmel® | SMART 8- and 32-bit MCUs with BLE connectivity



BLE Soc	BTLC1000	SAMB11
CPU Core	Cortex-M0 @ 26MHz	Cortex-M0 w/256KB stacked Flash
Max PHY Rate	1Mbps	1Mbps
Frequency	2.4GHz	2.4GHz
Stacks	Self Contained GATT and GATT-based profiles BLE 4.1	Self Contained GATT and GATT-based profiles BLE 4.1
Applications	Wearable, IoT	Wearable, IoT
Interfaces	SPI, UART, I2C, 13/15 GPIO	SPI, UART, I2C, 30 GPIO
Tx/Rx Peak (mA)	<3/4mA @ 3.6V	<3/4mA @ 3.6V
Tx Pout	-30dBm to +4dBm	-30dBm to +4dBm
Rx Sensitivity	<-95dBm	<-95dBm
Sleep Mode	<1uA	<1uA
Package	4x4mm QFN 32L 2.25 x 2.15mm WLCSP	6x6mm QFN 48L
Power Supply	(*) 1.8V-4.3V	2.3-3.6V
Temp Range	-40 to +85° c	-40 to +85° c

- Smallest, certified modules available on the market
- 4.5x5.5mm ultra small form factor LGA package
- Integrates all BOM components except 32kHz optional Xtal
- Available with integrated antenna on package or with hookup for external antenna

Atmel Smart Metering

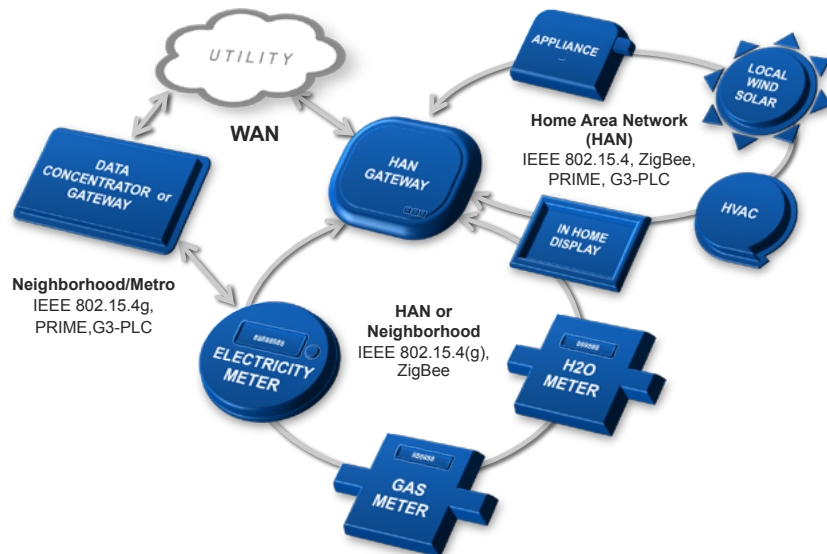
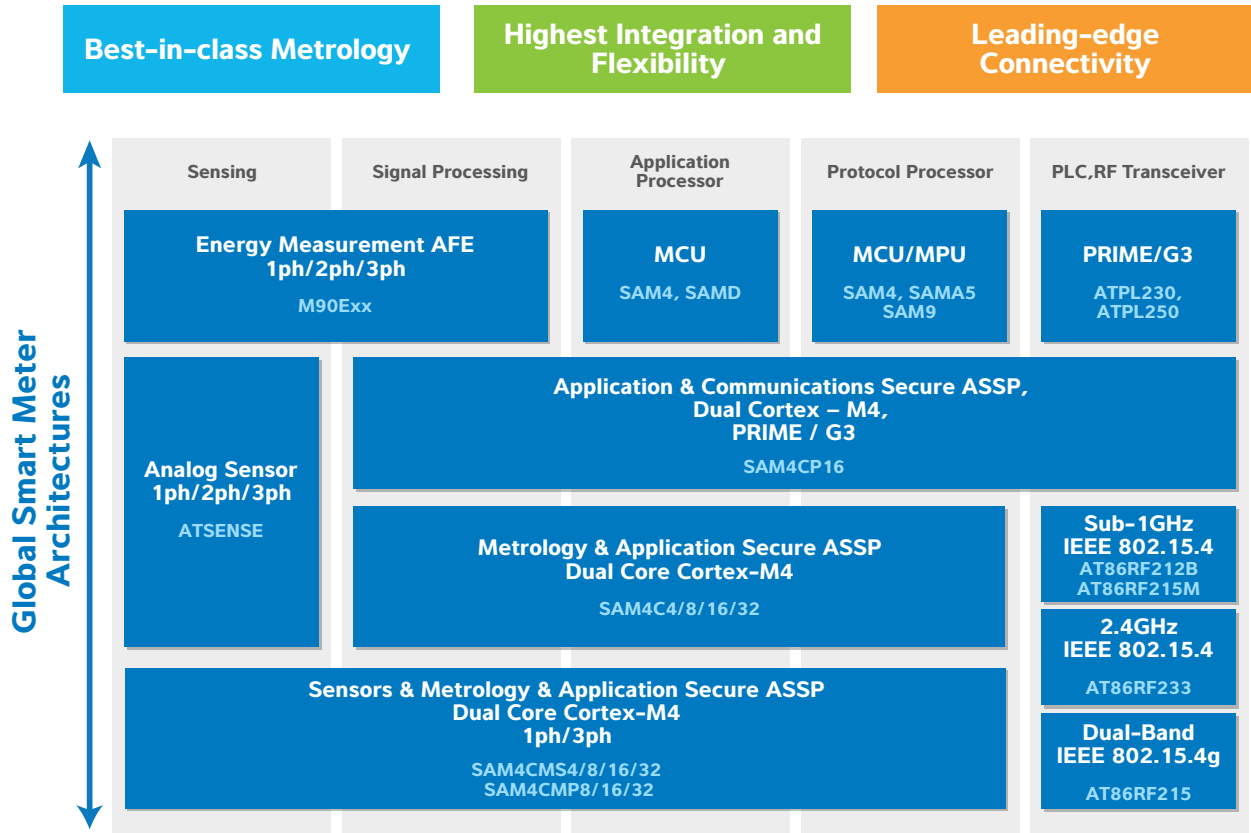

Atmel Security Solutions

More than a simple password

- Trusted and Secure Communication
- Secure updates for FW and SW
- Establish and manage Trusted Keys
- Manage and track production builds
- Authentication and verification
- Secure Boot
- Maintain Platform Integrity
- Product Lifecycle Management
- Stored Protection of Data

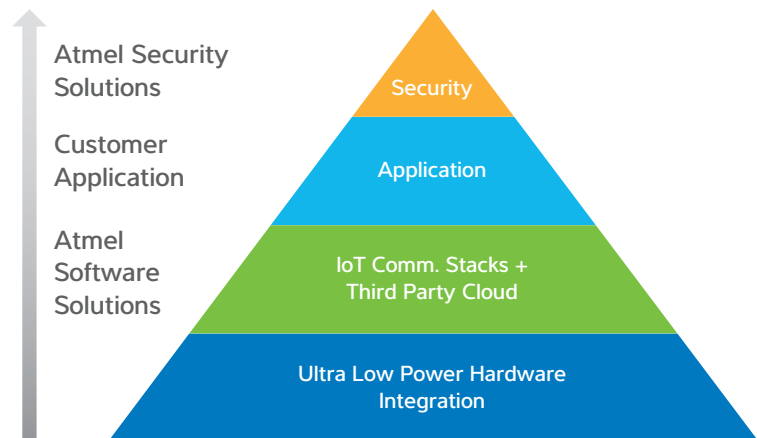

Part Number	ATSHA204A	ATAES132A	ATECC508A
Description	Secure authentication and validation device	High-Security, serial EEPROM providing authentication and confidential nonvolatile storage	High speed PKI crypto engine with secure key storage. FIPS186-3 Elliptic Curve Digital Signature Algorithm (ECDSA) for ECC Sign-Verify
ECDH			Runs FIPS SP800-56A ECDH Algorithm
Function(s)	Authentication	Encryption/Authentication	Authentication and key exchange for confidentiality and data integrity

Security Threats for IoT are Everywhere

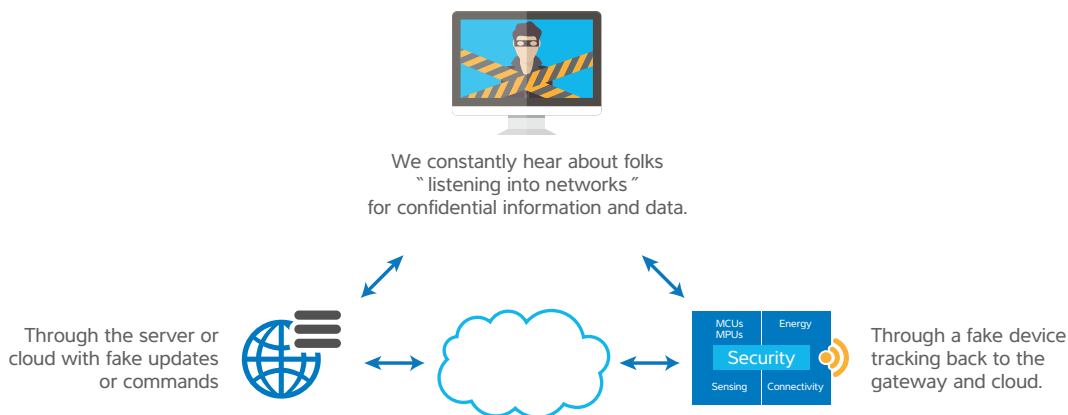

<http://www.atmel.com/security>

Atmel Memory Solutions

Atmel AT21CS Serial EEPROMs Powerful Capabilities in a Tiny Package

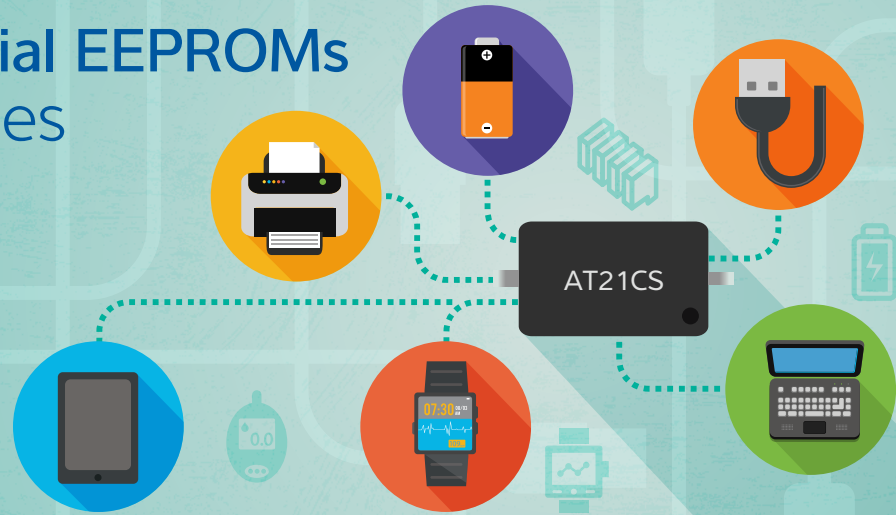

Serial EEPROM

Flexible memory devices for a variety of applications to store personal preference data, system calibration and configuration data, and high endurance data logging.

Parallel EEPROM

Byte alterable, parallel access memory devices with high endurance, long term data retention, and advanced features that ensure high quality and manufacturability of systems.

OTP EPROM

One-time Programmable (OTP) memory devices with fast parallel access times to provide secure, unalterable direct code execution memory.

In addition, Atmel offers a family of secure memory solutions that are specifically designed to prevent product counterfeiting and intellectual property theft.

CryptoMemory® EEPROMs

Memory solutions with a 64-bit embedded hardware encryption engine, four sets of non-readable, 64-bit authentication keys, and four sets of non-readable, 64-bit session encryption keys.

	I ² C	SPI	μWire	Single Wire
Device Family	AT24C/34Cxxx	AT25xxx	AT93Cxxx	AT21Cxxx
Densities	1-Kbit to 2-Mbit	1-Kbit to 2-Mbit	1-Kbit to 16-Kbit	1-Kbit
Voltage Range	1.7V to 5.5V	1.8V to 5.5V (Will migrate to 1.7V)	1.7V to 5.5V	1.7V to 4.5V
Clock Frequency	Up to 1MHz	Up to 20MHz	Up to 2MHz	n/a (up to 125 kbps)
Automotive Grade	Available	Available	Available	Available
Package Options	PDIP, SOIC, TSSOP, SOT-23, DFN, BGA, WLCSP	PDIP, SOIC, TSSOP, DFN, BGA, WLCSP	PDIP, SOIC, TSSOP, DFN, BGA, WLCSP	SOIC, SOT-23, WLCSP

48-bit MAC/EUI and 64-bit EUI Series

The 2Kb, I²C-compatible Atmel AT24MAC402 and AT24MAC602 Serial EEPROM devices are application-specific products that contain unique IEEE-provided 48-bit or 64-bit pre-programmed MAC/EUI addresses to enable connected devices to connect to the Internet or local network. The devices also contain a unique read-only 128-bit serial number and 2Kb of user-accessible EEPROM non-volatile memory (NVM) storage.

128-bit Serial Number Devices.

The Atmel AT24CS Series devices are general-purpose I²C-compatible Serial EEPROM devices that contain an Atmel-provided pre-programmed unique read-only 128-bit serial number with 1Kb to 32Kb of user-accessible EEPROM NVM storage.

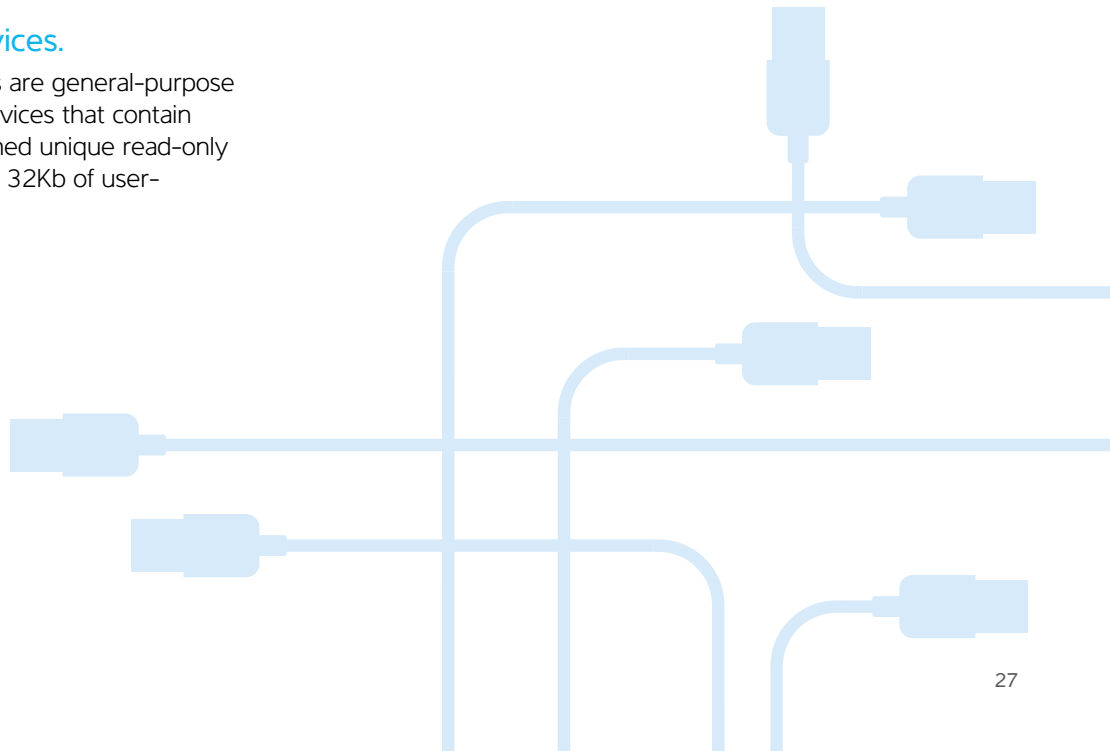



Atmel Corporation 1600 Technology Drive, San Jose, CA 95110 USA **T:** (+1)(408) 441. 0311 **F:** (+1)(408) 436. 4200 | **www.atmel.com**

© 2015 Atmel Corporation. / Rev.: Atmel-45154B-Product-Selection-Guide_E_US_121815

Atmel, Atmel logo and combinations thereof, Enabling Unlimited Possibilities, and others are registered trademarks or trademarks of Atmel Corporation in U.S. and other countries. ARM, ARM Connected logo and others are the registered trademarks or trademarks of ARM Ltd. Other terms and product names may be trademarks of others.

Disclaimer: The information in this document is provided in connection with Atmel products. No license, express or implied, by estoppel or otherwise, to any intellectual property right is granted by this document or in connection with the sale of Atmel products. EXCEPT AS SET FORTH IN THE ATMEL TERMS AND CONDITIONS OF SALES LOCATED ON THE ATMEL WEBSITE, ATMEL ASSUMES NO LIABILITY WHATSOEVER AND DISCLAIMS ANY EXPRESS, IMPLIED OR STATUTORY WARRANTY RELATING TO ITS PRODUCTS INCLUDING, BUT NOT LIMITED TO, THE IMPLIED WARRANTY OF MERCHANTABILITY, FITNESS FOR A PARTICULAR PURPOSE, OR NON-INFRINGEMENT. IN NO EVENT SHALL ATMEL BE LIABLE FOR ANY DIRECT, INDIRECT, CONSEQUENTIAL, PUNITIVE, SPECIAL OR INCIDENTAL DAMAGES (INCLUDING, WITHOUT LIMITATION, DAMAGES FOR LOSS AND PROFITS, BUSINESS INTERRUPTION, OR LOSS OF INFORMATION) ARISING OUT OF THE USE OR INABILITY TO USE THIS DOCUMENT, EVEN IF ATMEL HAS BEEN ADVISED OF THE POSSIBILITY OF SUCH DAMAGES. Atmel makes no representations or warranties with respect to the accuracy or completeness of the contents of this document and reserves the right to make changes to specifications and products descriptions at any time without notice. Atmel does not make any commitment to update the information contained herein. Unless specifically provided otherwise, Atmel products are not suitable for, and shall not be used in, automotive applications. Atmel products are not intended, authorized, or warranted for use as components in applications intended to support or sustain life.